



# Hans Sauer Award 2020

## Designing Circularity in the Built Environment

“Make, Use, Waste” – the prevailing linear way of thinking and acting puts severe pressure on the earth’s natural resources. How can this pattern be changed and how can modern life and our societies become more circular? Currently one of the most resource consuming sectors is the building and construction sector.

In Europe it accounts for approximately half of all extracted materials, half of total energy consumption, one third of water consumption and one third of waste generation. The Hans Sauer Award 2020 „Designing Circularity in the Built Environment“ focuses on changing practices in the system that produce the “built environment” of cities and landscapes. “Built environment” refers to human-made surroundings that provide the setting for human activity, ranging from buildings to neighborhoods and cities themselves. The interdisciplinary competition not only wants to reward building new structures, but will also honor tools, methods and concepts that deal with the circular transformation of the already enormous quantity of existing constructions and/or structures. Additionally, the award focuses on people and projects that create and spread knowledge on the importance of circularity in the built environment.

The Hans Sauer Foundation is focused on fostering a “Circular Society” – in the Netherlands manifold actors do so for quite some time. This led to the idea to initiate a German-Dutch competition that not only awards outstanding projects, but also aims to foster the exchange of knowledge and experience between the two countries. The Dutch Consulate General and Stichting Circulair Bouwen, two high quality partners, have joined in announcing this competition.

# Designing Circularity

## in the Built Environment

### A German-Dutch Competition

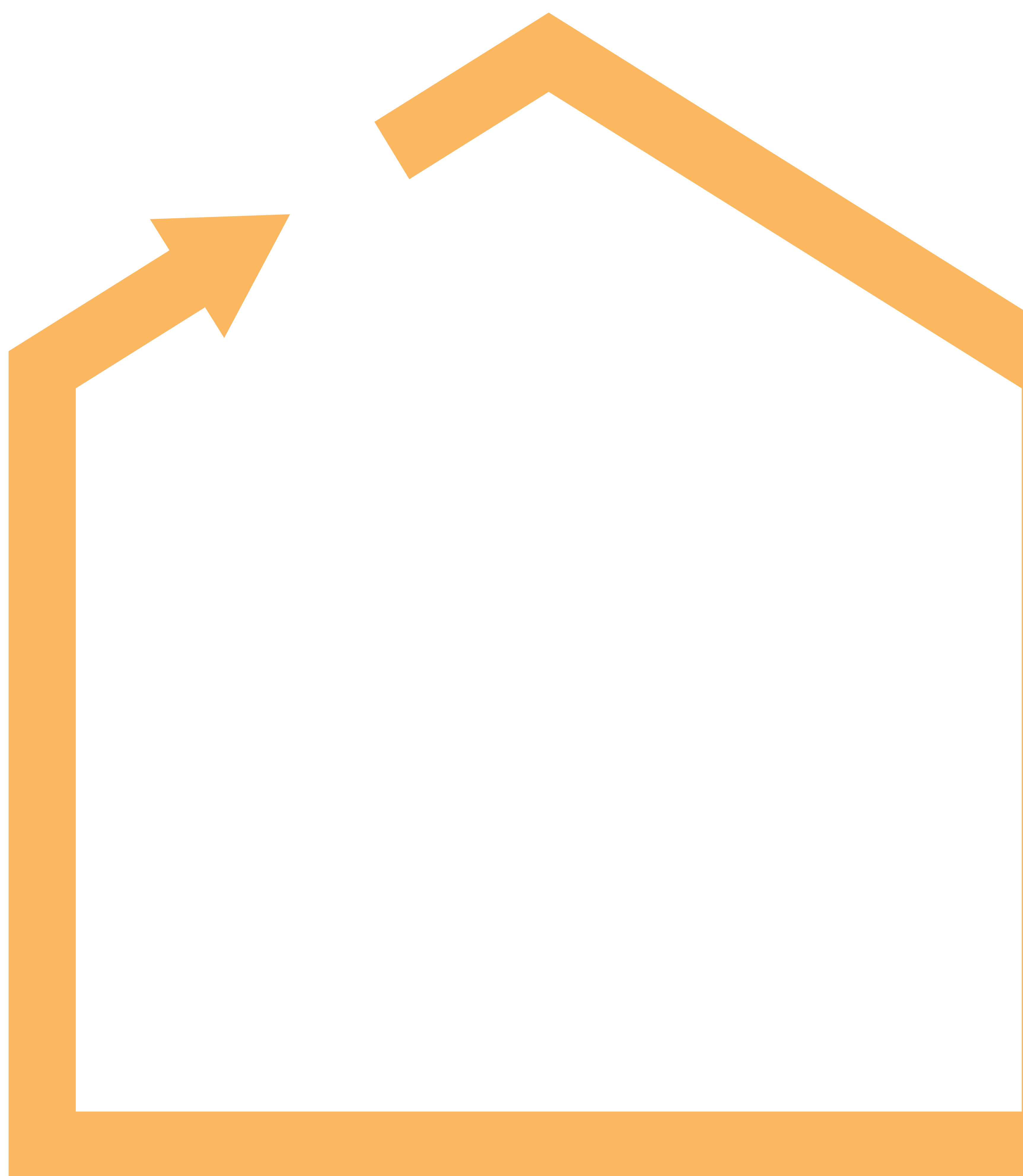

# Kita Karoline Goldhofer

## Day-care center

“Kita Karoline Goldhofer” originates from the Reggio pedagogy approach which is embedded in the concept. The founder family’s old house became a part of the day-care centre. Reuse and recycling, as one of the pedagogy’s basic ideas, were introduced to the children as social and ecological values.

For this purpose, the three existing building sections got preserved, exempted and encased under a new shell of polycarbonate multiwall sheets. The resulting spaces are part of the sustainable, cybernetic energy concept. The facade, as a “solar air collector”, allows the existing walls to remain uninsulated and to be experienced as a historical layer. The energetic renovation has an architectural-spatial approach. The project supports circularity in the built environment.

The transferability of the concept lies in the architectural-constructional solution of the significantly relevant questions of how to deal with used building materials and how to combine energy-saving and CO2 neutrality with benefit for the space and usability. The interaction between the existing building stock, shell, use and energy is decisive; the further development of the insulation question is also important.

The demonstration value of the “Kita Karoline Goldhofer” is high. Working with existing buildings is becoming increasingly important, especially in the context of climate protection. With its innovative and future-oriented energy concept, the day-care centre is considered a best practices project for further building projects.

[www.heilergeiger.de](http://www.heilergeiger.de)

[post@heilergeiger.de](mailto:post@heilergeiger.de)

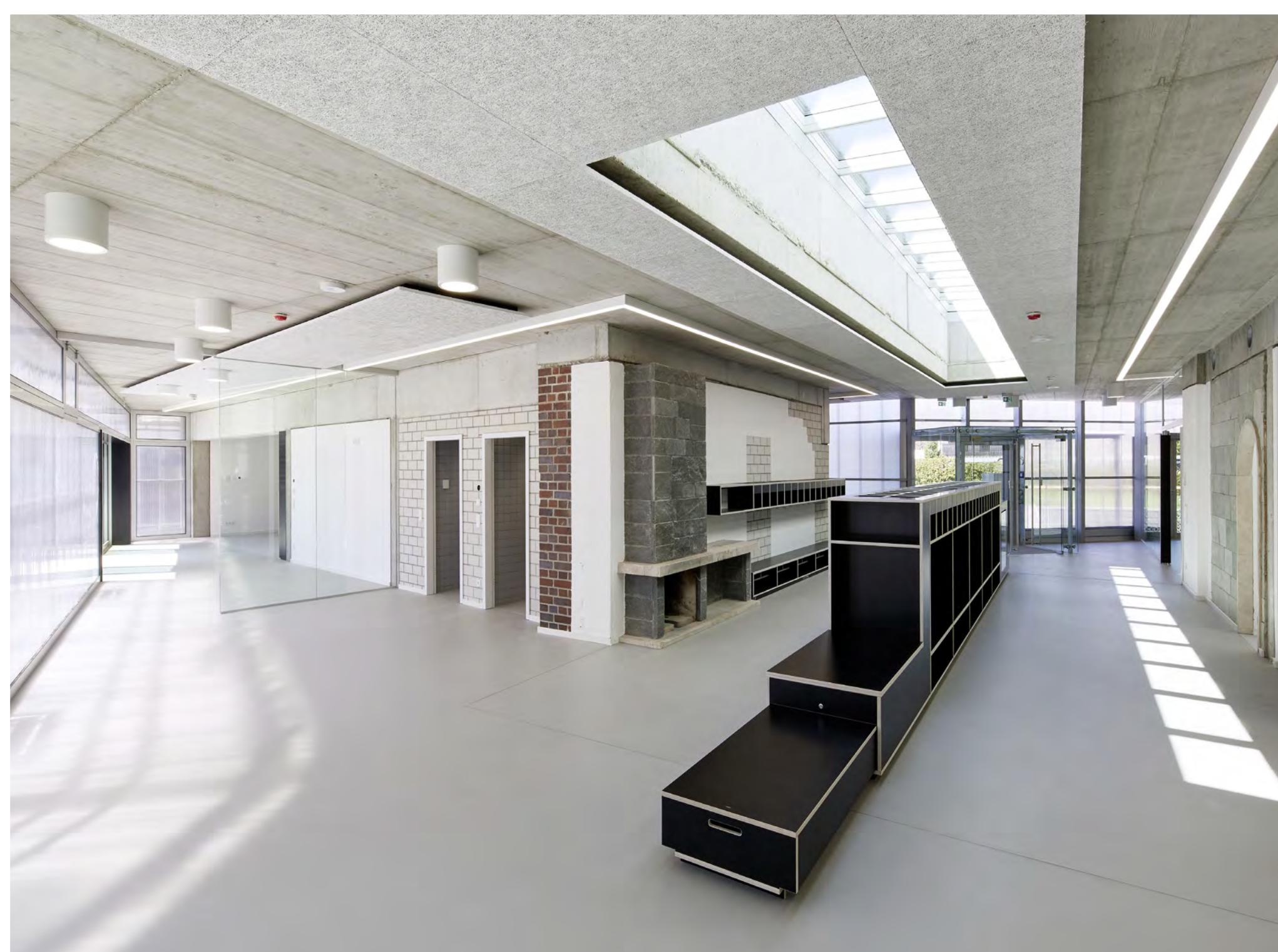

## CiWoCo 1.0

### Circular live-work housing block

CiWoCo 1.0 is an experimental circular live-work housing block in which future inhabitants were involved in the design process. It is located in Buiksloterham, a former industrial area in North of Amsterdam designated as a circular architecture testing ground. It is GAAGA's first realised building in a series of circular and adaptive designs, based on John Habraken's concept of "Open Building" and fitting with circular design strategies such as the 10 R's of circular economy of Jacqueline Cramer, and the building layer model of Stewart Brand.

Usually, the building process is linear: materials are sourced, processed, transported and installed in buildings, only to be later down-cycled or scraped. However, CiWoCo 1.0 maintained a circular approach in all stages of the design and building's lifespan, resulting in a design with a highly demountable and adaptive character, unconventional building techniques, and an innovative application of reused materials. By doing so, the building can adapt to future changes (both in use and function) without major structural changes, and 90% of the used building materials can be reused or recycled at the end of building's life, therefore functioning as a future material bank. Also, other sustainability themes, such as energy reduction (almost energy neutral) and biodiversity were applied.

With CiWoCo 1.0, GAAGA shows the possibilities and usability of circular design and construction within residential projects, hopefully inspiring and giving others an incentive for change as well.

[www.gaaga.nl](http://www.gaaga.nl)

[info@gaaga.nl](mailto:info@gaaga.nl)

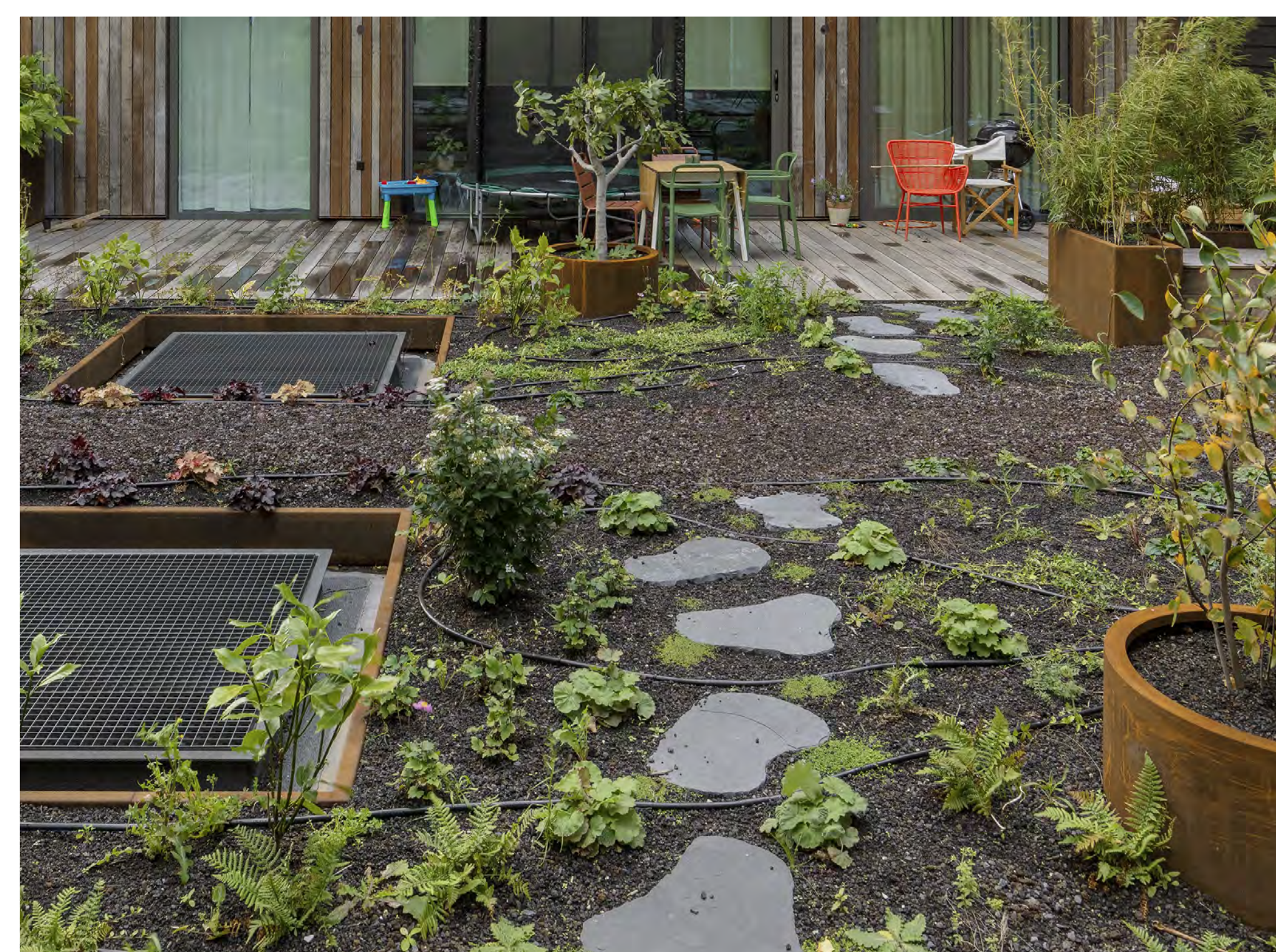
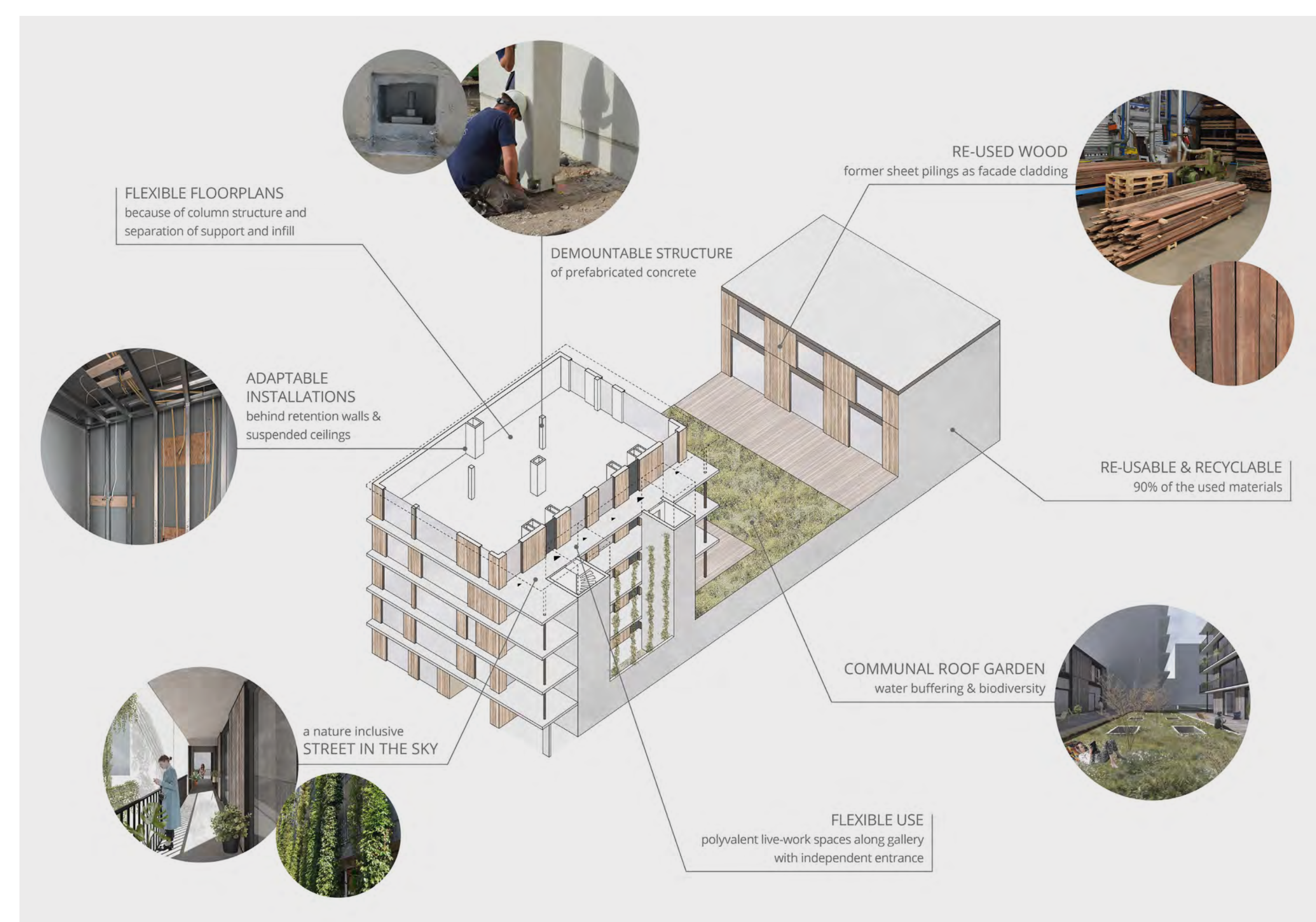

# RE4

## REuse, REcycling, Refabricated and Refurbishment

The construction sector is responsible for the largest waste stream in Europe, generating approx. 800 million tonnes of Construction and Demolition Waste (CDW) every year. The EU Waste Framework Directive 2008/98/EC requires of all member states to achieve 70% reuse, recycling or other recovery methods of non-hazardous CDW by 2020.

In response, an international team of researchers and experts developed an innovative, holistic RE4 design for a 100% prefabricated, energy-efficient, seven-storey residential building, constructed from reused elements, with an average of 80% recycled CDW materials. The concept can be adapted to specific project requirements, including office buildings. Recycling rates for structural concrete were increased by 100% through innovative sorting and the successful handling of varying incoming CDW qualities, whereas a new approach for waste wood handling led to 80% to 90% higher replacement rates of structural timber. Furthermore, RE4 showcases a solution on how to construct a fully dismantlable and reusable building so that future generations of waste are limited to a bare minimum. Proof of concept was delivered by constructing two two-storey demo buildings, one in the cold and one in the warm European climate. The developed solutions reduced the environmental impact by 38% to 64% respectively in comparison to conventional ones.

RE4 has been developed while accounting for market expectations and scientific aspirations to find a suitable balance between stakeholder requirements and the developed technical solutions.

[www.re4.eu](http://www.re4.eu)

[info@re4.eu](mailto:info@re4.eu)

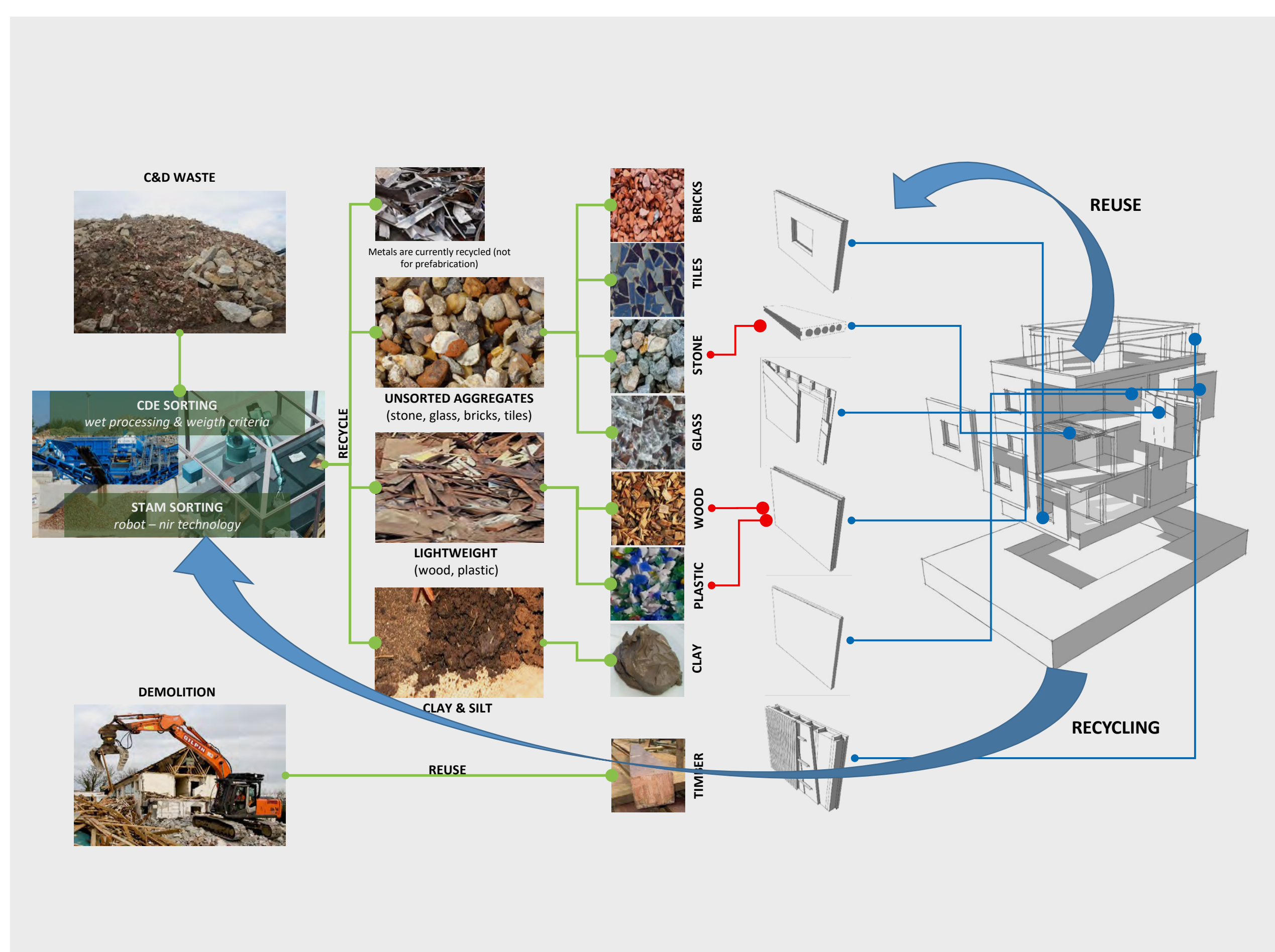
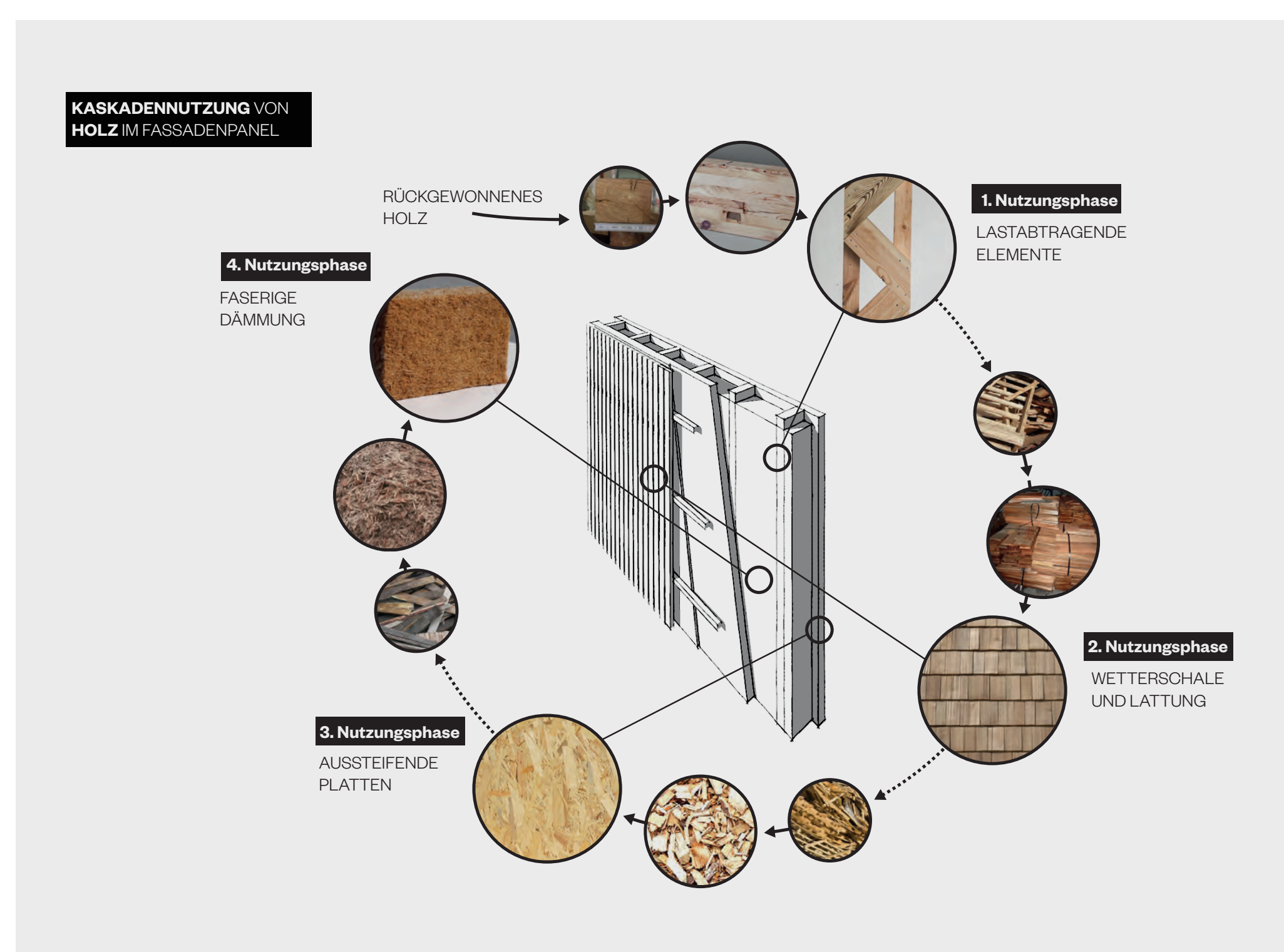

# fo(u)r friends

## Himalaya school extension

After Nepal's earthquake in 2015 SUPERTECTURE designed and built four additional rooms in the school of the mountain village Dhoksan in Nepal. In order to display some of Nepal's unlimited possibilities for reused, recycled, regenerative and circular construction technologies, we decided to build every room as an individual house - every "class house" built with different innovative and underestimated materials: free donated "earthquake" bricks, earth+bamboo+straw, "earthquake"-rocks + rocky slades, 700 old "earthquake" windows.

In the context of a social building project, we realised a variety of different examples for circularity in Nepals built environment. The primary aspects of our circularity approach were reutilisation of manmade construction elements, as well as the research and application of natural degradable and renewable building materials such as earth, bamboo and straw.

A secondary aspect of our circularity approach to building was the creative diversity of many smart and innovative ideas for recycled or degradable houses within a single primary school extension complex. Our concept did not focus on a single circular building solution but a wide-ranging and colourful building exposition. The innovation of our architecture consists of the individual material approaches and a radical arrangement of many different ideas under the greater umbrella of broad possible circularity in Nepal's built environment. Besides the architecture itself, it is innovative for young architects to undertake a design and construction project with sufficient time for on-site research and analysis.

[www.supertecture.com](http://www.supertecture.com)

[pr@supertecture.com](mailto:pr@supertecture.com)

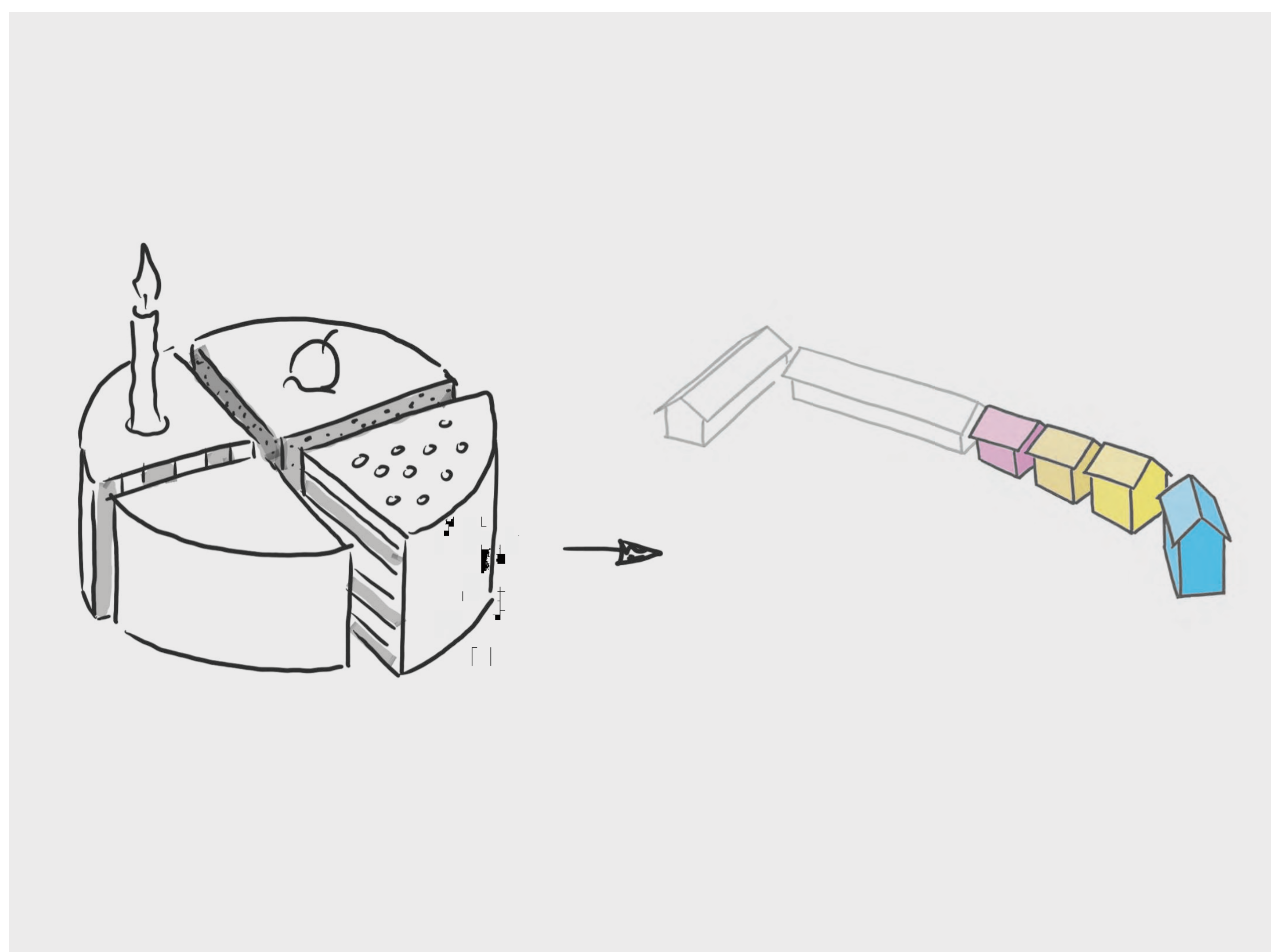

# People's Pavilion

## Towards a circular world

We explored the possibilities of creating a structurally sound building without damaging the materials in any way. To do this, we had to devise a construction technique that didn't use glue, screws or nails. The frame was built up from standard, off-the-shelf, timber sections of different trade lengths tied together with steel straps to make longer and stronger composite elements. The columns consisted of seven-meter tall prefab concrete foundation piles. Steel rods from a demolished office building were reused as cross bracing. The composite timber beams, concrete columns and cross bracing were tied together using high capacity ratchet straps to create a safe and sufficiently rigid structure to withstand strong wind conditions.

This unconventional system required our calculations to be validated, which was done by executing several experiments in cooperation with the Technical University Eindhoven. The glass roof was borrowed from a greenhouse supplier and the lower glass facade was saved from a demolished office building. The plastic shingles on the façade were made from plastic waste collected by the inhabitants of Eindhoven.

After the event, the building was successfully dismantled, and all the materials were returned to the suppliers. By demonstrating ways of borrowing and returning materials, the pavilion is a great example of circular design and construction, making sure materials maintain their high value in the chain.

[www.arup.com/projects/peoples-pavilion](http://www.arup.com/projects/peoples-pavilion)  
[amsterdam@arup.com](mailto:amsterdam@arup.com)

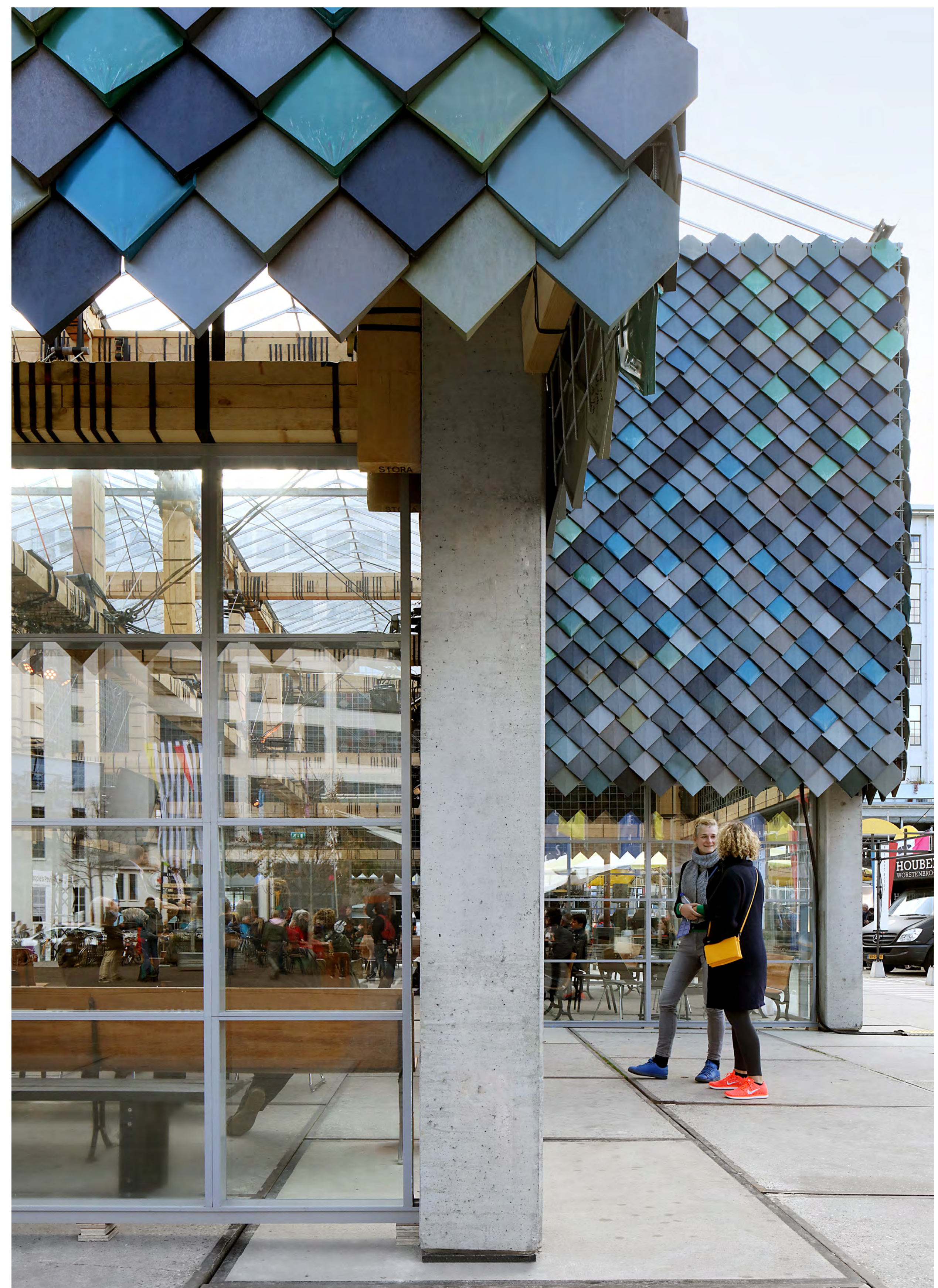

# Manual of Recycling

## Buildings as sources of materials

How is it possible to keep the immense deposits of raw materials in buildings “active” and realise environmentally sustainable buildings in the long term? Besides “sufficiency, consistency and efficiency”, this goal implies the intelligent use of resources, the recyclability of structures, circular construction methods that reuse decommissioned materials; in short, “urban mining.” This poses a significant challenge for architects and engineers, requiring them to rethink the planning and execution of building construction. The publication “Manual of Recycling– Buildings as a source of materials” provides the necessary expertise for the associated paradigm shift in the construction sector. In addition to successful project examples, this comprehensive and detailed guide provides in-depth explanations on calculation methods and tendering aspects.

Some main topics of the content are:

- Recyclable construction
- Urban Mining – resource city and buildings
- Structures that can be dismantled
- Design and design methodology in the life cycle
- A detailed guide of relevant construction component connections

We are faced with a major challenge that represents a society-wide, global necessity. We see this as an opportunity to take a new, concept-based architectural stance that puts a new sense of responsibility at the forefront of every aesthetic debate.

[www.shop.detail.de/de/atlas-recycling.html](http://www.shop.detail.de/de/atlas-recycling.html)

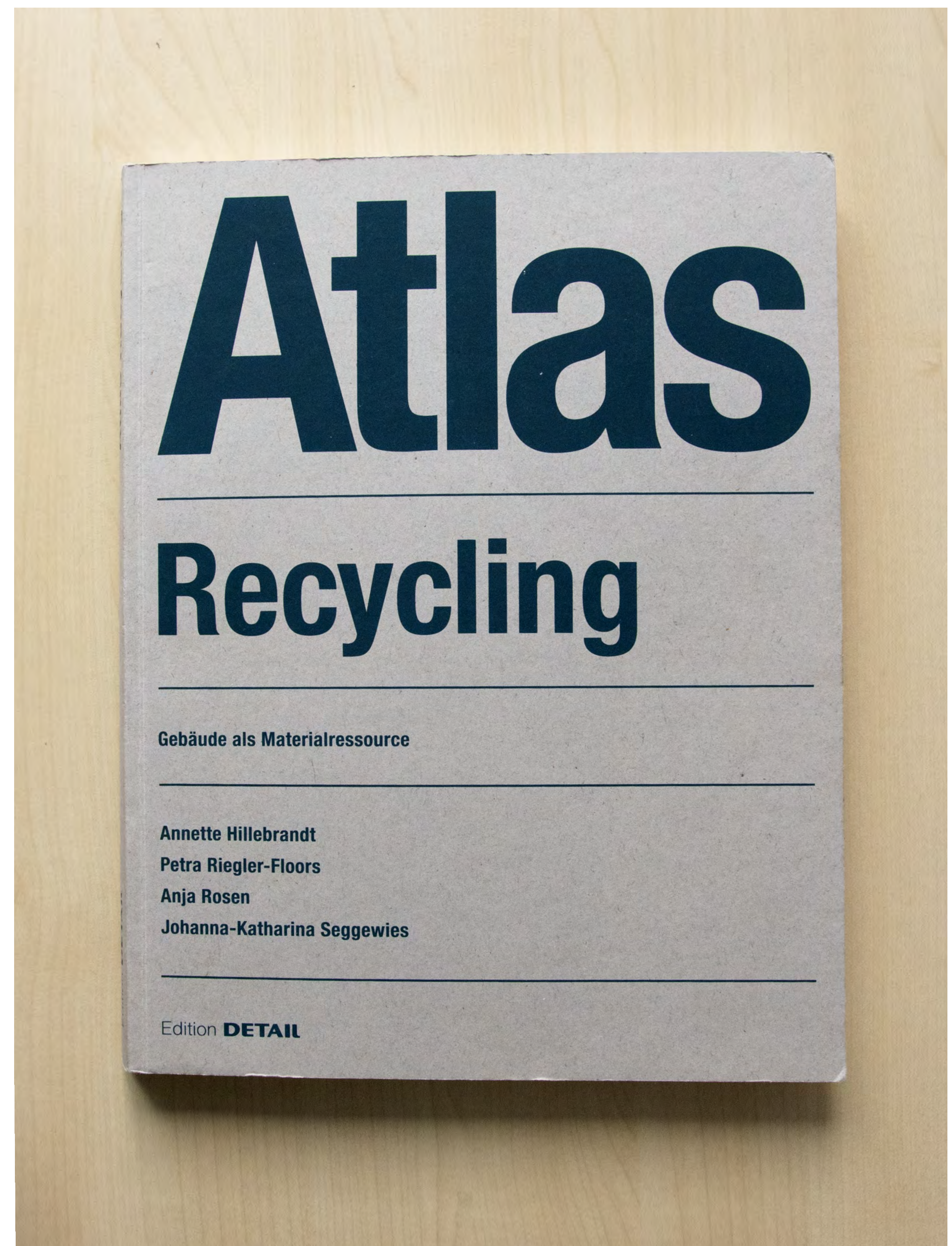
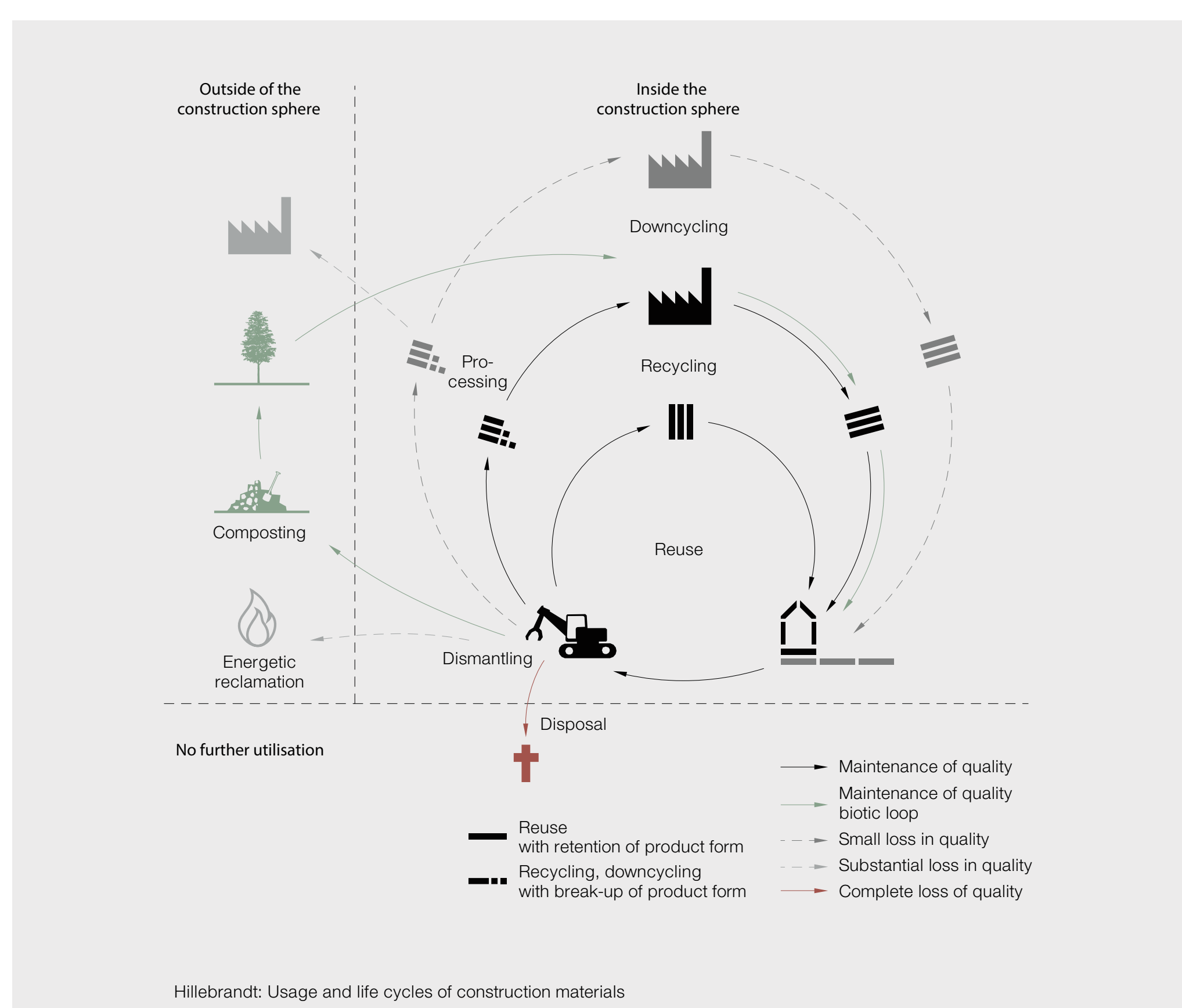

# Component Reuse Network

## Conservation, conversion and the creative use of materials

The federal association has been supporting the reuse of used building materials, residual building materials from construction sites and measured building products since 2011. The prevention of waste is our top priority. Therefore it is our target to raise awareness of the true value of our built environment. Conservation, conversion and the creative use of materials for recycling are practiced and passed on.

For new construction projects, dismantling is recommended and a material passport is required. On our homepage, knowledge is shared and information about current developments are provided. In addition, student work is accompanied and there is always room for questions! Direct reuse not only avoids waste; it also saves energy and reduces CO<sub>2</sub>. In addition, the use of space for raw material extraction and landfill are becoming increasingly important. Regional systems are stimulated to pool competencies and powers. Through national and European activities, many projects have been initiated and supported in their practical work. The knowledge gained is passed on, discussed and updated through lectures and further training offers. The networking of actors is particularly important to us. In addition, the first component catalogue for component exchanges was created, which today is used by students and research projects for the exchange of information.

[www.bauteilnetz.de](http://www.bauteilnetz.de)

[info@bauteilnetz.de](mailto:info@bauteilnetz.de)

